

DAIHATSU

F300

[HD-ENGINE]







SSTs



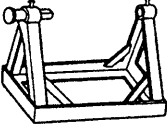
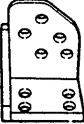

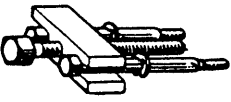

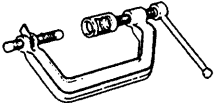
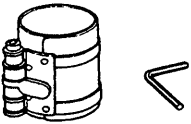
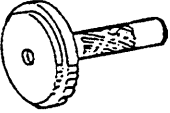
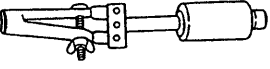
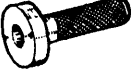

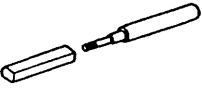
SSTsA-2

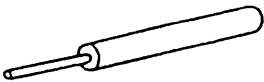
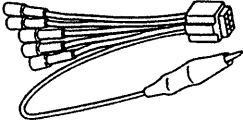
WR88-SST001

A

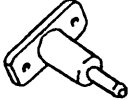
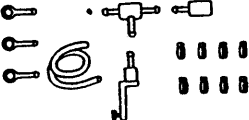

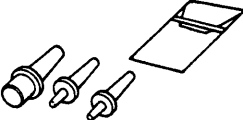

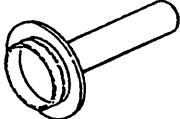
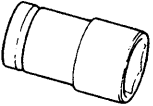
SST (Special Service Tools)

Shape	Part No. and Name	Purpose	Remarks
	* ⁵ 09090-04010-000 Engine sling device	Removal and installation of engine	
	* ⁵ 09219-87202-000 Engine overhaul stand	Stand for engine overhaul	This stand is to be used in combination with engine overhaul attachment.
	* ¹ * ⁵ 09219-87701-000 Engine overhaul attachment	Attaching engine to overhaul stand (However, it is necessary to modify attachment.)	This attachment is to be used in combination with engine overhaul stand.
	09210-87701-000 Flywheel holder	Preventing crankshaft from turning	
	09609-20011-000 Steering wheel puller	Removal of crankshaft timing belt pulley	
	09636-20010-000 Upper ball joint dust cover replacer	Installation of camshaft oil seal	
	* ⁵ 09202-87002-000 Valve cotter remover & replacer	Installation and removal of valves	
	* ⁵ 09217-87001-000 Piston replacing guide	Guiding piston during insertion	
	09223-41010-000 Crankshaft rear oil seal replacer	Installation of crankshaft rear oil seal	
	09201-87704-000 Valve stem oil seal cover	Removal of valve stem oil seals	
	09310-87102-000 Counter shaft front bearing replacer	Installation of crankshaft front oil seal	
	* 09221-87704-000 Piston pin remover & replacer body	Removal and installation of piston pins	This remover & replacer body is to be used in combination with piston pin remover & replacer guide.
	* 09221-87705-000 Piston pin remover & replacer guide	Removal and installation of piston pins	This remover & replacer guide is to be used in combination with piston pin remover & replacer body.

Shape	Parts No. and Name	Purpose	Remarks
 *	09201-87705-000 Valve guide bush remover & replacer	Removal and installation of valve guide bushes	
	09991-87702-000 Engine control system inspection sub harness	* Shorting terminal T * Actuating fuel pump, etc.	Only for HD-E engine
	09842-87701-000 EFC-II computer check sub harness	Inspection of computer input/output voltage	Only for HD-E engine
 *	09842-30070-000 EFI inspection wire F	Inspection of fuel injectors	Only for HD-E engine
	09268-87701-000 EFI fuel pressure gauge	Inspection of fuel pressure	Only for HD-E engine
 *	09283-87703-000 Pressure regulator adopter	* Inspection of injectors * Inspection of pressure regulator * Inspection of fuel pressure	Only for HD-E engine
	09268-87702-000 Injection measuring tool set	* Inspection of injectors * Inspection of pressure regulator * Inspection of fuel pressure	Only for HD-E engine
 *	09301-87601-000 Clutch guide tool	Assembling clutch	
	09258-00030-000 Plug set	Plugging rubber hoses	
	09860-11011-000 Carburetor screwdriver set	Overhaul of carburetor	Only for HD-C engine
 *	09388-87702-000 Transfer replacer	Press-fitting of rubber grommets	
 *	*2 09268-87704-000 Oil cooler set bolt box wrench	Removal and installation of oil cooler (only for oil cooler-equipped vehicle)	Only for oil cooler-equipped vehicle

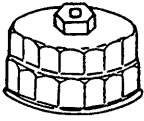
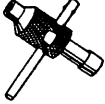
WN88E-SST001

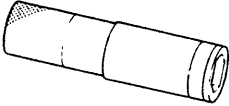
SSTs

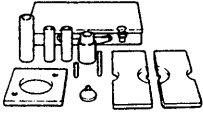
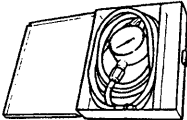
Shape	Parts No. and Name	Purpose	Remarks
	09032-00100-000 Oil pan seal cutter	Removal of oil pan	
	09228-87201-000 Oil filter wrench	Removal and installation of oil filter	
	09243-00020-000 Idle adjust wrench	Adjustment of idle mixture adjusting screw	Only for HD-C engine
	09240-00020-000 Wire gauge set	Adjustment of carburetor	Only for HD-C engine
	09240-00014-000 Carburetor adjusting gauge set	Adjustment of carburetor	Only for HD-C engine
 *	*3 *5 09268-87703-000 Plug wrench	Removal and installation of spark plugs	
 *	*4 09991-87703-000 Tacho pulse pick-up wire	Connecting engine tachometer	Only for HD-C engine
	09236-00100-000 Water pump overhaul tool	Assembling alternator rear bearing cover	
	*5 09990-87702-000 Engine oil pressure gauge	Measurement of engine oil pressure	

WN88E-SST002

NOTE:

* Newly provided SST

*1 Modification required for engine overhaul attachment

It is necessary to modify the engine overhaul attachment as indicated below.

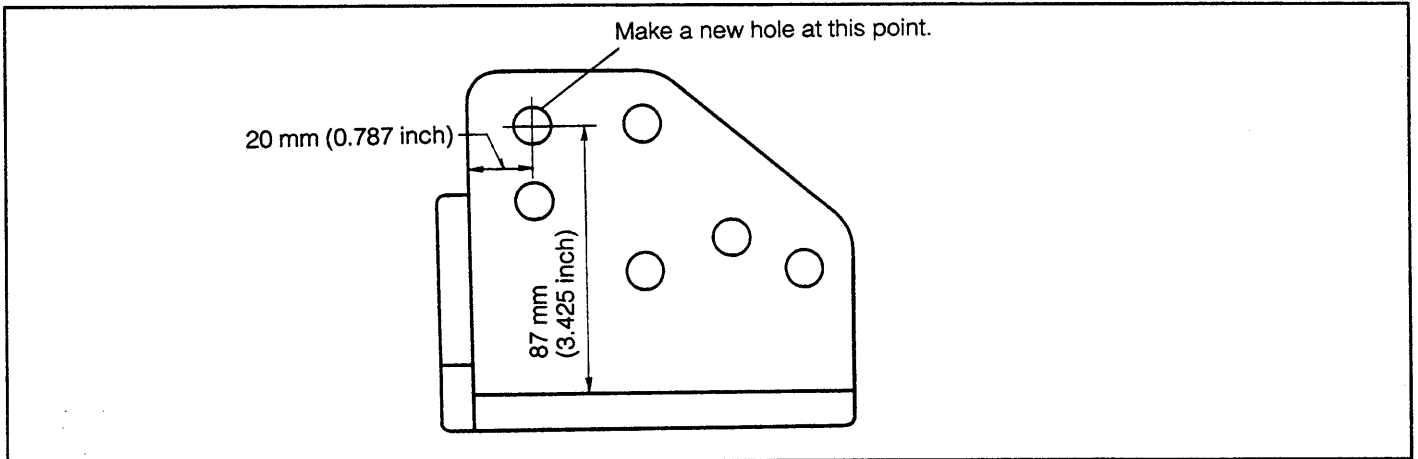

*2 There is no need for the oil cooler set bolt if your box wrench satisfies the following requirements.

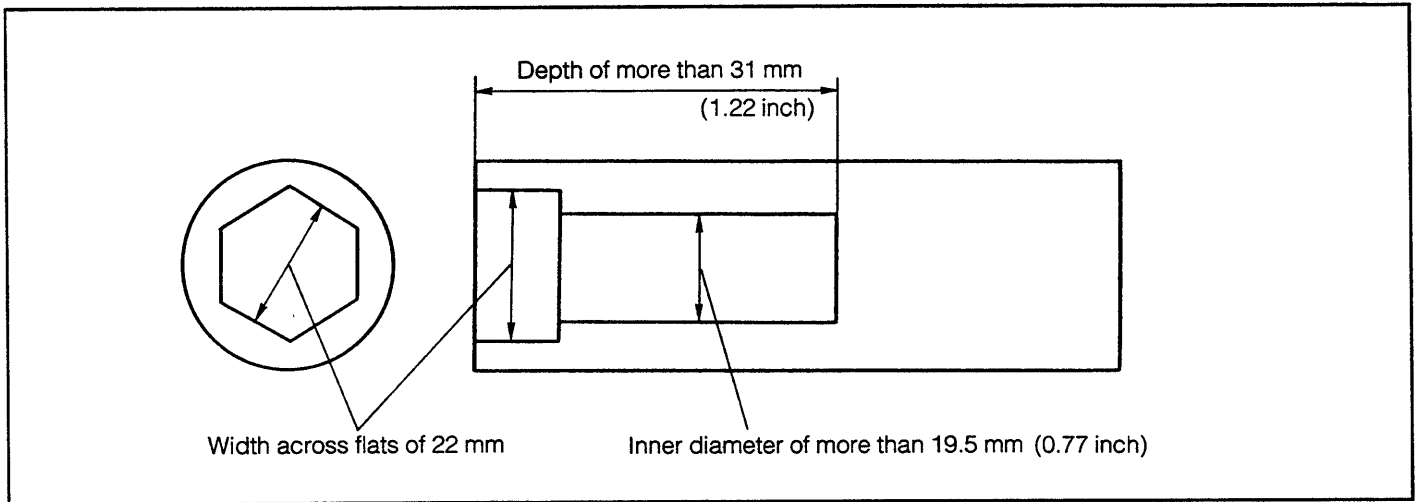

*3 There is no need for the spark plug wrench if your spark plug box wrench satisfies the following requirements.

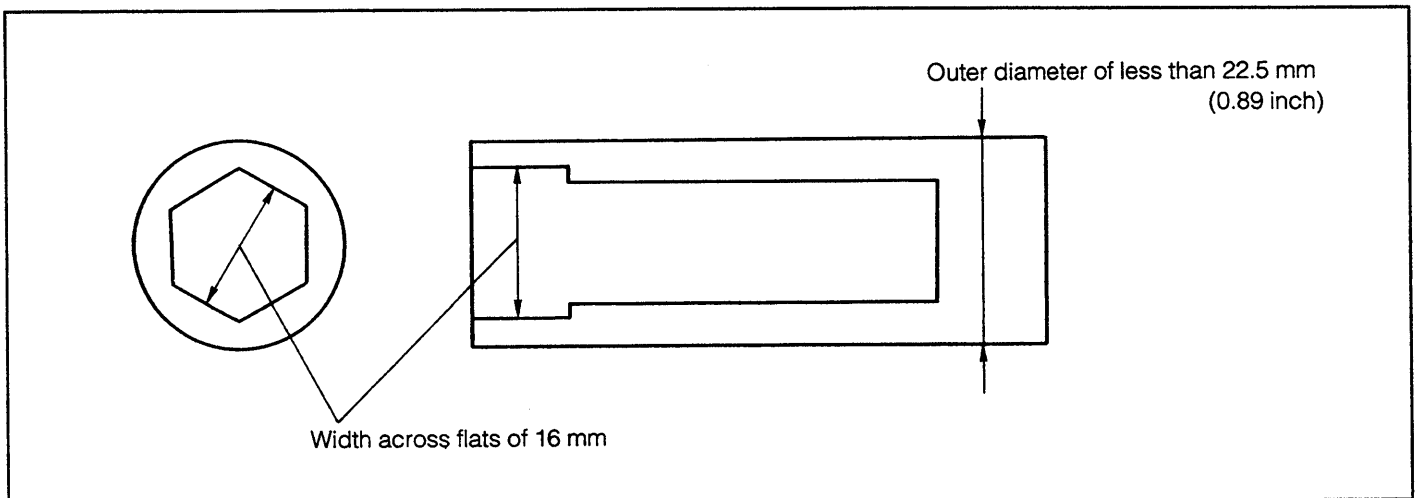

*4 Not required, if your tachometer is a clamp-on type.

*5 Commercially-available

Reference:

LIST OF EQUIPMENT AND OTHER TOOLS REQUIRED

General Tools

General Service Equipment

- Two-post lift
- Garage jack
- Safety stands
- Valve refacer
- Valve seat cutters
- Hydraulic press
- Ridge reamer
- Air compressor
- Reamer

WR88-SST006

Measuring Equipment

- Torque wrench
- Vernier calipers
- Dial gauge (with magnet base)
- Dial caliper gauge (for bore measurement use)
- Micrometers (for bore measurement use and depth measurement use)
- Thickness gauge
- Tachometer and dwell angle tester
- Ohmmeter, ammeter and voltmeter (Circuit tester)
- Straightedge
- Surface plate
- Spring tester
- Compression gauge
- Hydrometer
- Battery tester
- Square gauge
- Megger (ohmmeter)
- Spring scale
- Connecting rod aligner

WN88E-SST003

Consuming Articles

- Plastigauge
- Blue lead or red lead
- Dye penetrant
- Compound (for valve lapping)
- Solvent
- Engine oil (10W-30/SE or higher)

WR88-SST008

Liquid Gasket

Nomenclature	Application	Part number
Three Bond 1104	Camshaft bearing cap and cylinder head cover gasket section (arched section), etc.	999-04808-U9-005
Three Bond 1377B	Spark plug tube, heater outlet pipe and heater union	999-04808-U9-004
Three Bond 1207C	Oil pan, rear oil seal retainer and oil pump	999-6313-6323-00
Three Bond 1324	Flywheel bolt	999-04808-U9-006

WR88-SST009